

# Bldc Motor BK90 (고출력형)



## SPECIFICATION

MODEL		BK90(고출력형)									
		S012100	S012120	S012150	S024200	S024250	S024300	S220300	S220400	S220500	S220600
Rated Voltage	V	12			24			220			
Rated Output	W	100	120	150	200	250	300	300	400	500	600
Rated Current	A	13.5	15.8	19.5	11.9	14.8	17.8	3.4	4.1	5.5	6.3
Rated Speed	r/min	3000									
Rated Torque	kgf-cm	3.2	3.9	4.8	6.3	7.9	9.5	9.5	13.0	16.2	19.5
Weight	kg	2.2	2.5	2.8	2.2	2.5	2.8	2.2	2.2	2.5	2.8
Applicable Driver		SBDM-25A					SBDSMD-05A				

L	MODEL
81.3	S220300 / S220400
91.3	S012100 / S024200 / S220500
101.3	S012120 / S024250 / S220600
111.3	S012150 / S024300

## TORQUE CURVE

BK90-S012100

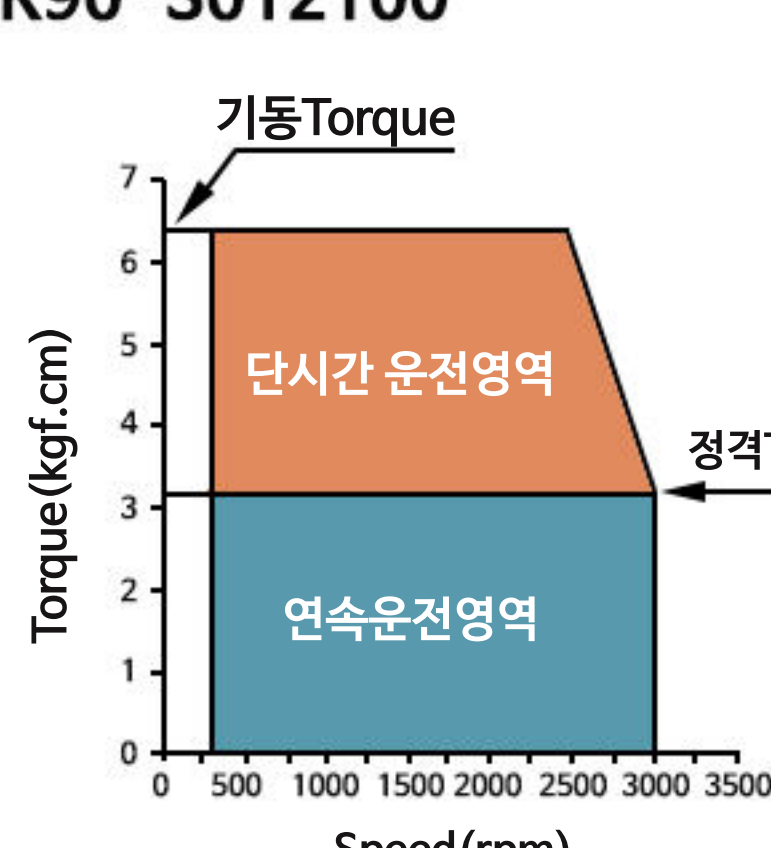

BK90-S012120

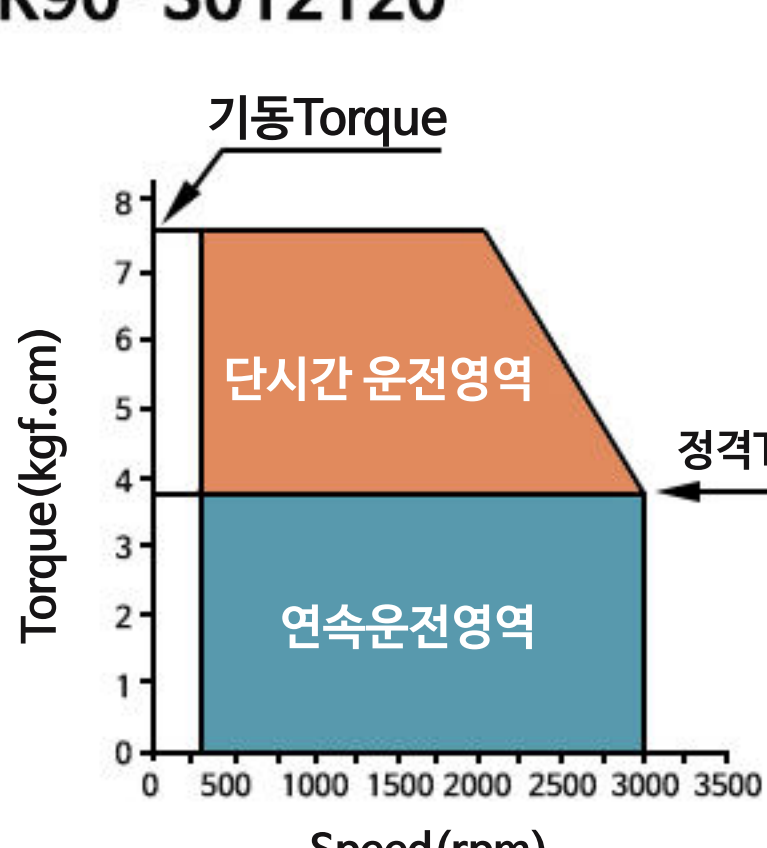

BK90-S012150

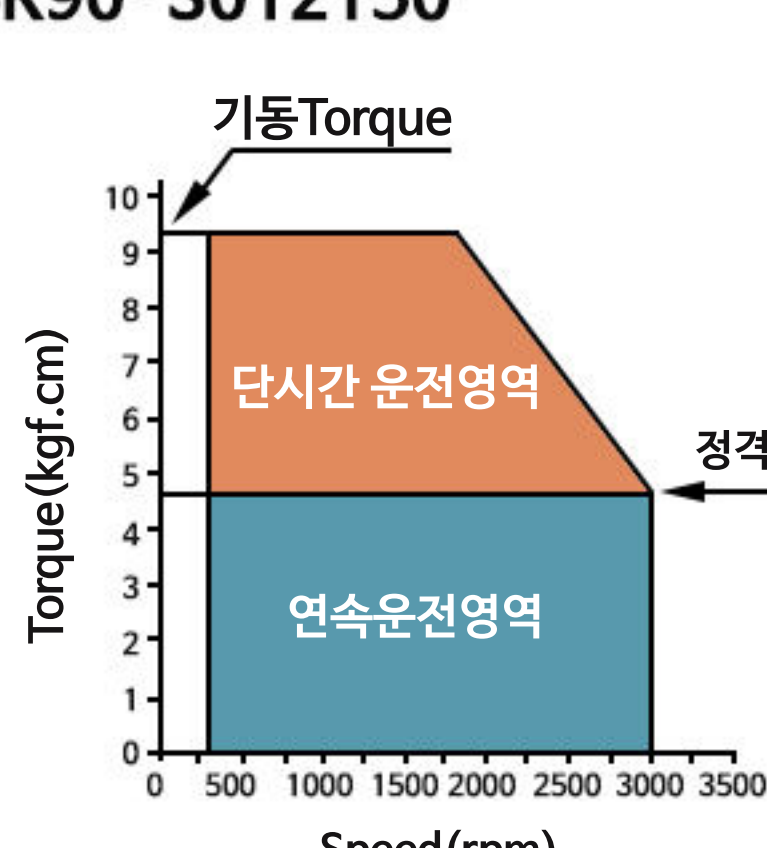

BK90-S024200

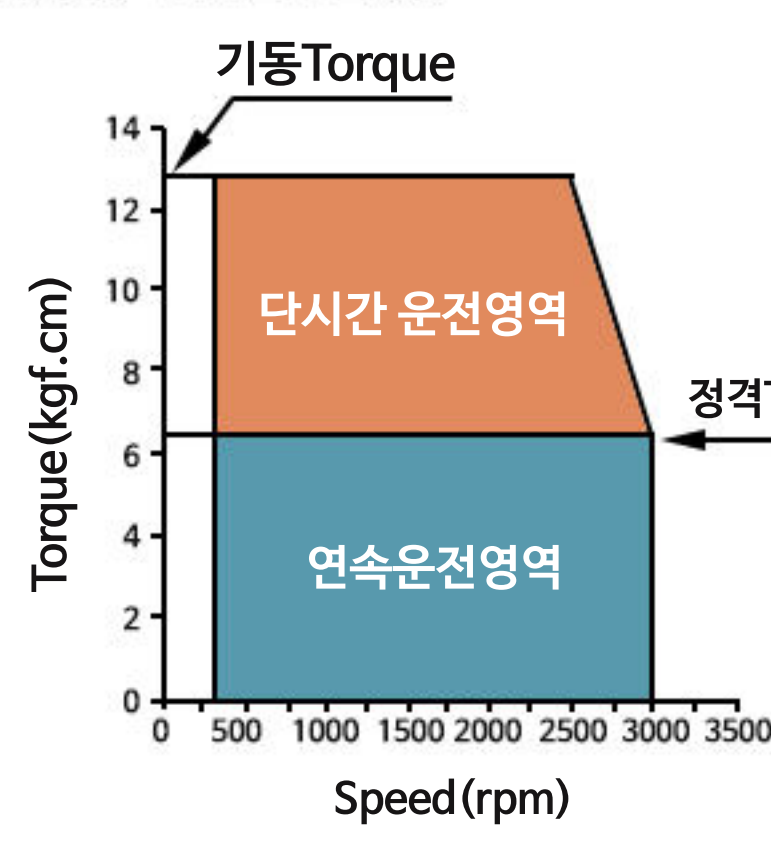

BK90-S024250

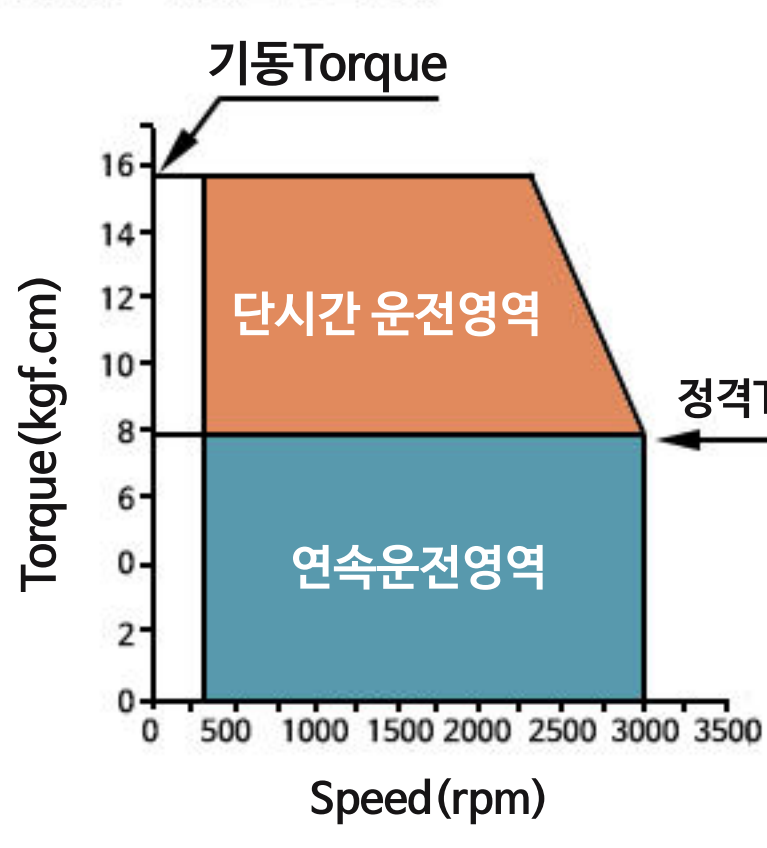

BK90-S024300

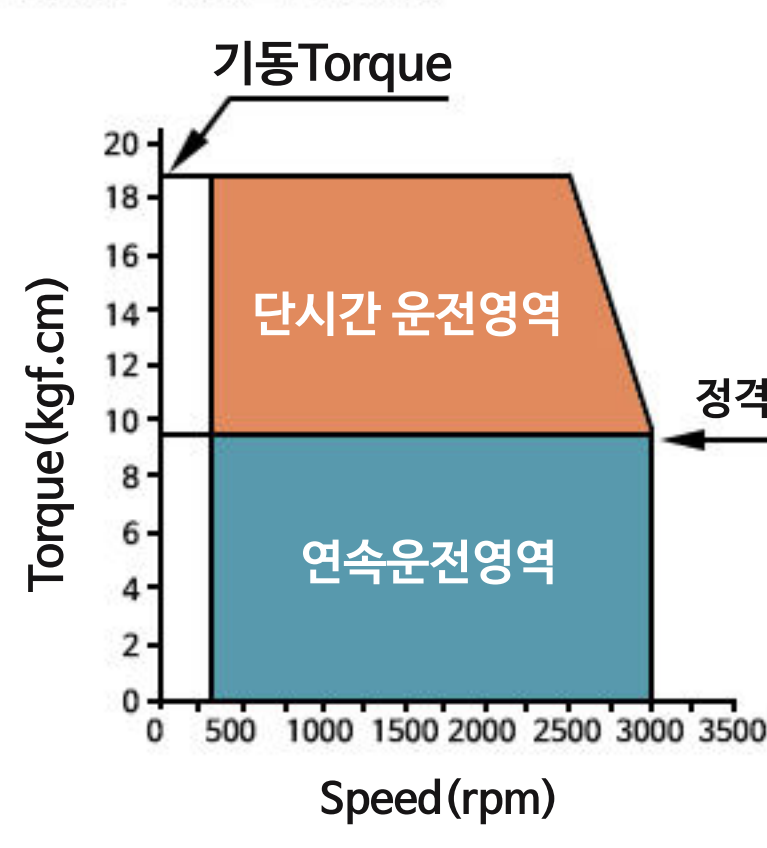

BK90-S220300

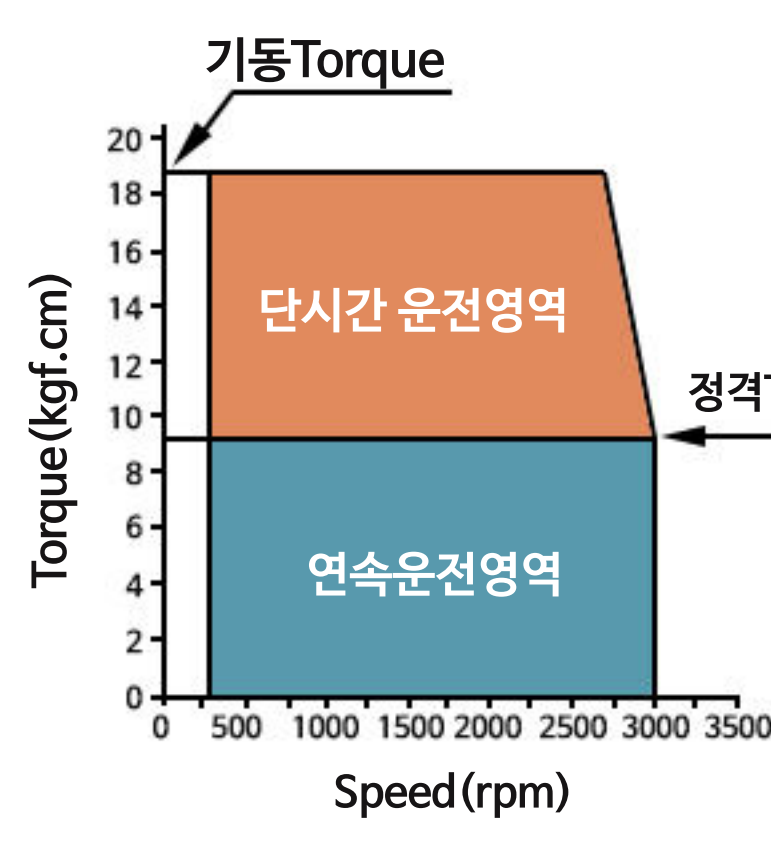

BK90-S220400

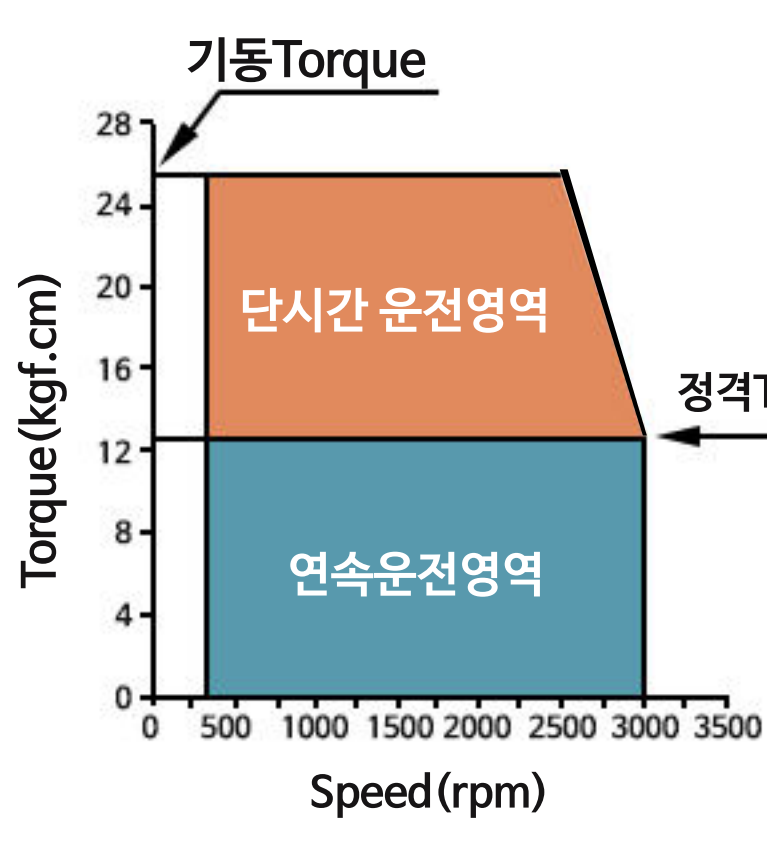

BK90-S220500

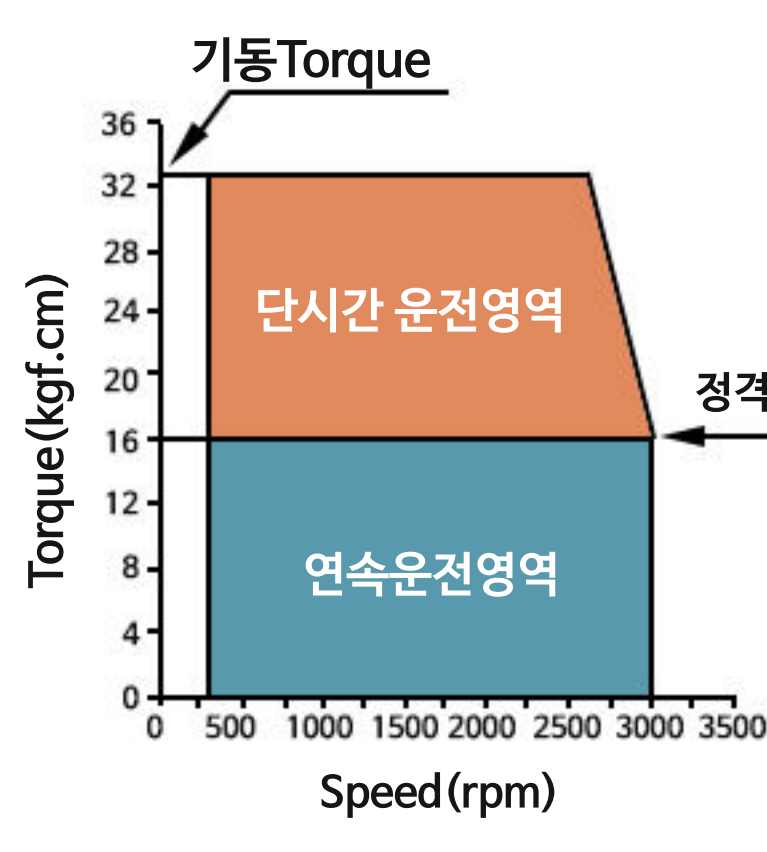

BK90-S220600

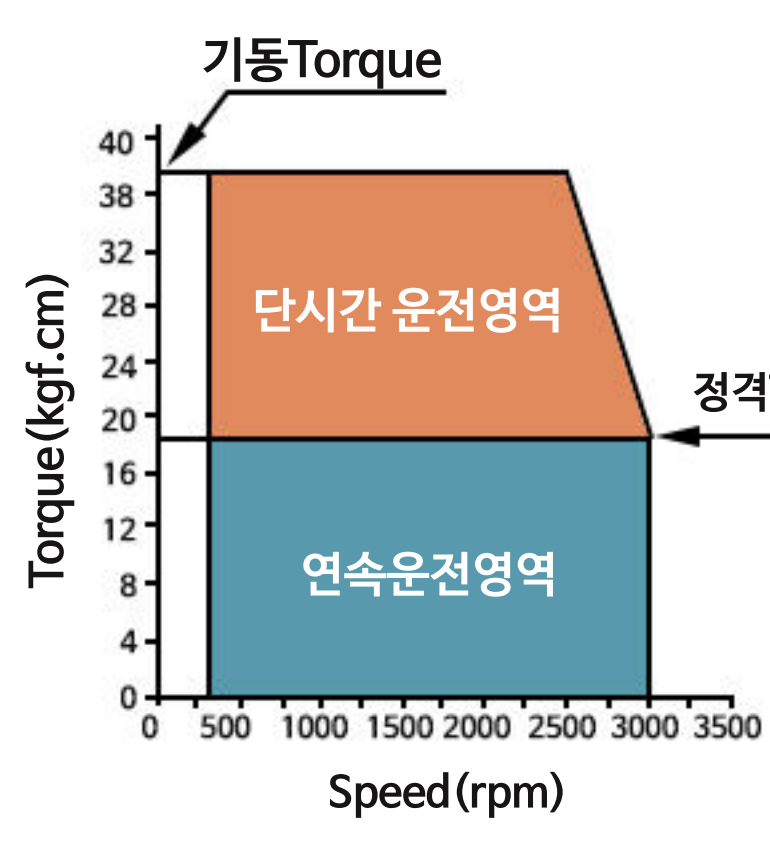

## DIMENSIONS (mm)

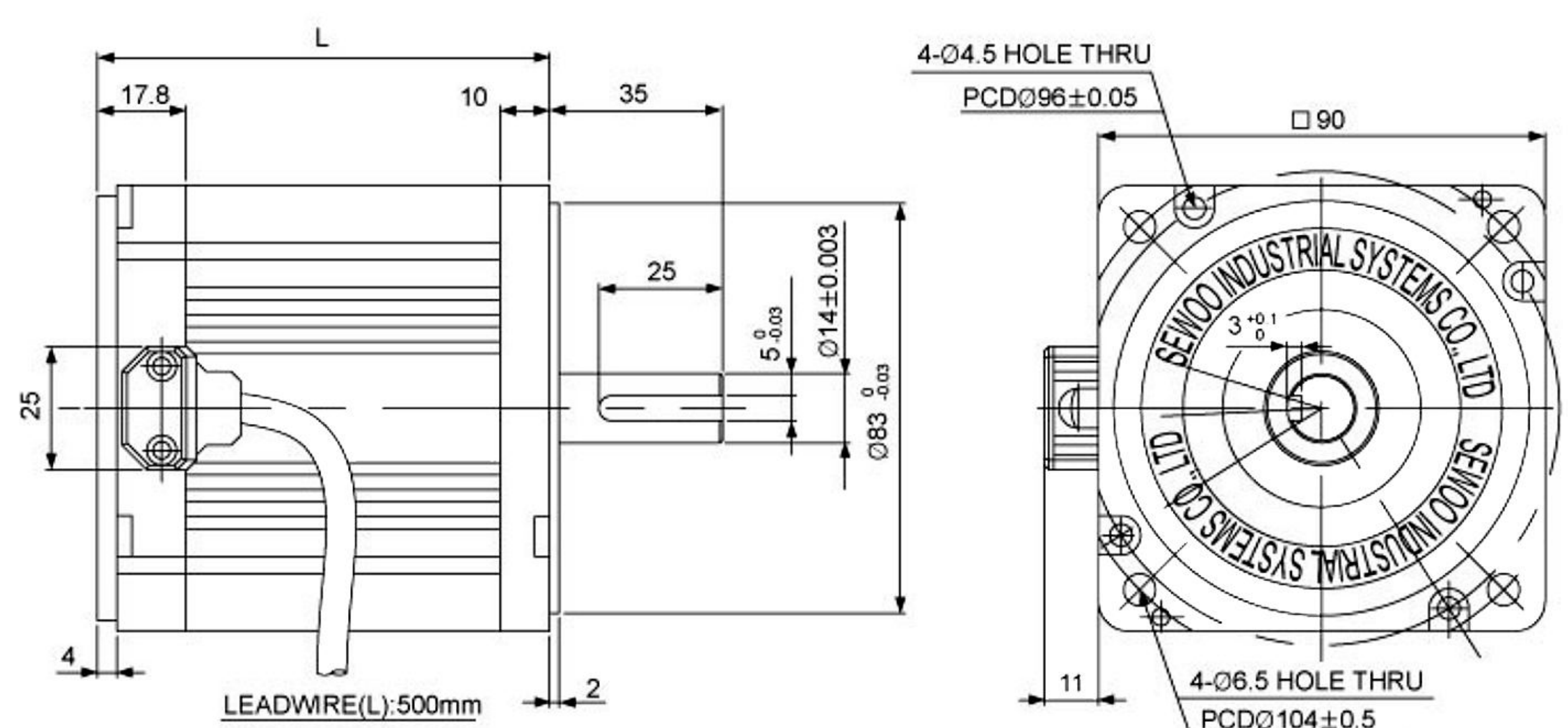

## CONNECTION

### CONNECTOR(5557-12)

PIN NO	Cable Color	Lead Wire	Remark
1	BLUE	AWG 20	W
2			
3			
4	BROWN	AWG 24	Hw
5	GREEN	AWG 24	Hv
6	WHITE	AWG 24	Hu
7	YELLOW	AWG 20	V
8	RED	AWG 20	U
9	SHIELD		
10			
11	ORANGE	AWG 24	Vcc
12	BLACK	AWG 24	GND

CONNECTOR : MOLEX 5557-12 (AC POWER용)

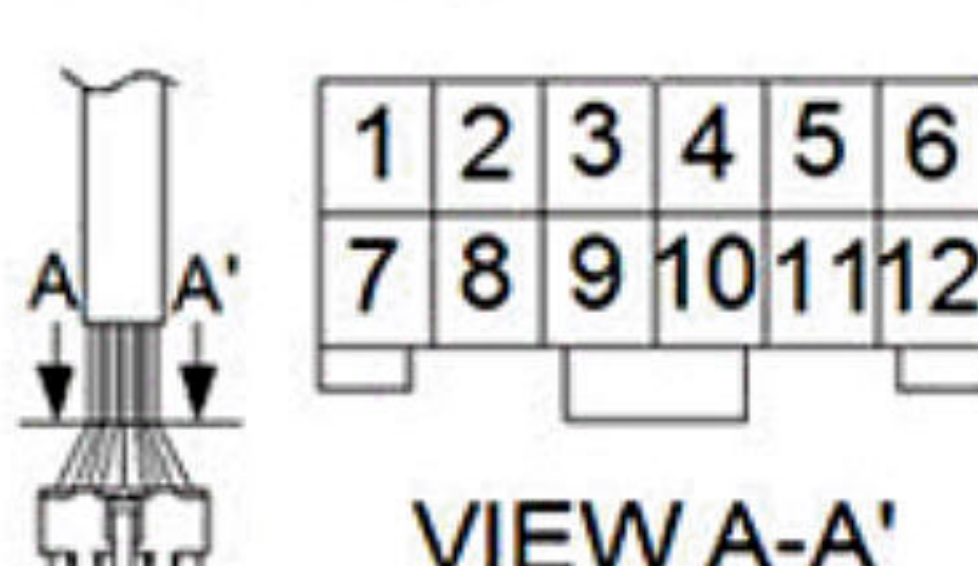

### 1.CONNECTOR(5264-05)

PIN NO.	Cable Color	Lead Wire	Remark
1	WHITE	AWG 24	Hu
2	GREEN	AWG 24	Hv
3	BROWN	AWG 24	Hw
4	BLACK	AWG 24	GND
5	ORANGE	AWG 24	Vcc

CONNECTOR : MOLEX 5264-05 (SBDM-25A)

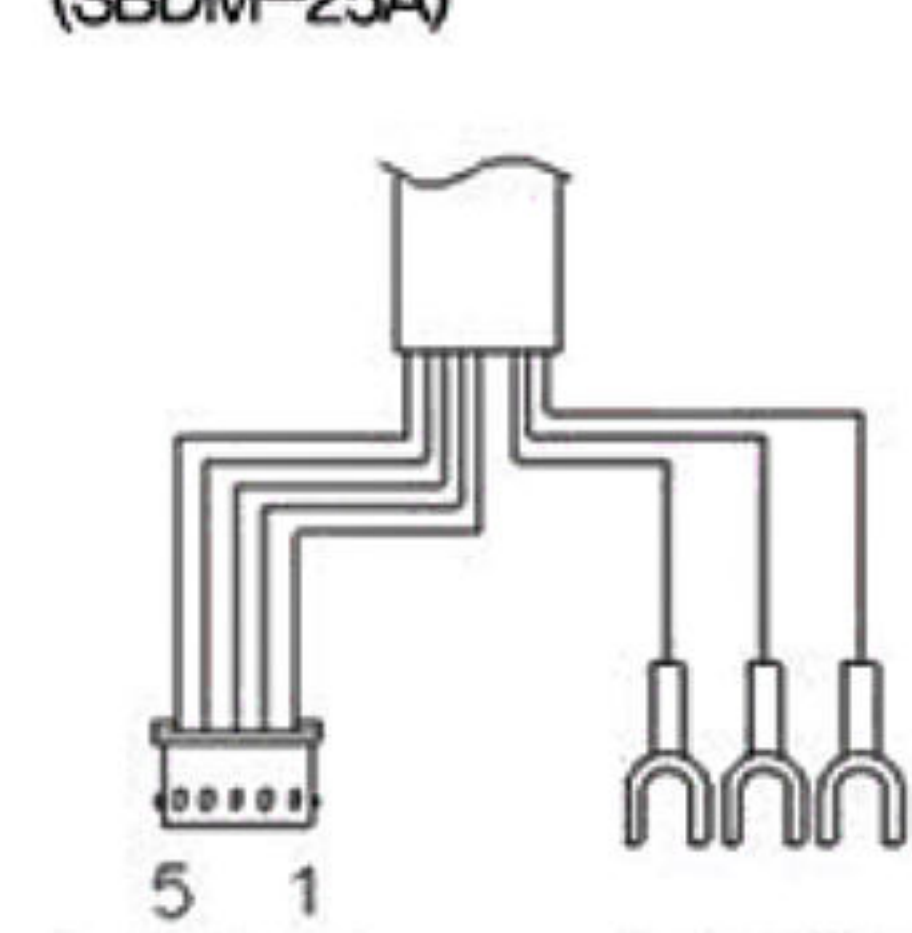

### 2.CONNECTOR

PIN NO.	Cable Color	Lead Wire	Remark
1	RED	AWG 16	U
2	YELLOW	AWG 16	V
3	BLUE	AWG 16	W